



**DM&P Vortex86DX2 Panel PC
with 5.7" TFT LCD**

- **Model:**
PDX2-057T-5A / PDX2-057T-8A
PDX2-057T-5A-2G / PDX2-057T-8A-2G

User's Manual

(Revision 1.1A)



CE



FCC



VCCI



VIBRATION



TOUCH



Wi-Fi



FANLESS

Revision

<i>Date</i>	<i>Version</i>	<i>Description</i>
2016/11/18	Version 1.0	Initial Release
2017/01/10	Version 1.1	Specification correction

Copyright

The information in this manual is subject to change without notice for continuous improvement in the product. All rights are reserved. The manufacturer assumes no responsibility for any inaccuracies that may be contained in this document. And makes no commitment to update or to keep current the information contained in this manual.

No part of this manual may be reproduced, copied, translated or transmitted, in whole or in part, in any form or by any means without the prior written permission of the ICOP Technology Inc.

©Copyright 2017 ICOP Technology Inc.
Manual No. IUMPDX2057-01 Ver.1.1A Jan, 2017

Trademarks Acknowledgment

Vortex86DX2™ is the registered trademark of DMP Electronics Inc. Other brand names or product names appearing in this document are the properties and registered trademarks of their respective owners. All names mentioned herewith are served for identification purpose only.

Safety Information

- Read these Safety instructions carefully.
- Make sure the voltage of the power source is correct before connecting the equipment to the power outlet.
- Do not expose your Panel PC to rain or moisture, in order to prevent shock and fire hazard.
- Keep PDX2-057T away from humidity.
- Do not open the cabinet to avoid electrical shock. Refer to your nearest dealer for qualified personnel servicing.
- Never touch un-insulated terminals or wire unless your power adaptor is disconnected.
- Locate your Panel PC as close as possible to the socket outline for easy access and to avoid force caused by entangling of your arms with surrounding cables from the Panel PC.
- USB connectors are not supplied with Limited Power Sources.
- If the equipment is not used for a long time, disconnect it from the power source to avoid damage by transient overvoltage.

DO NOT ATTEMPT TO OPEN OR TO DISASSEMBLE THE CHASSIS (ENCASING) OF THIS PRODUCT. PLEASE CONTACT YOUR DEALER FOR SERVICING FROM QUALIFIED TECHNICIAN.

Table of Contents

Table of Contents.....		iii
1	.General Information	1
	1.1 Product Description.....	1
	1.2 Product Specification	2
	1.3 Inspection standard for TFT-LCD Panel	4
	1.4 Product Dimension.....	7
	1.5 Ordering Information	8
	1.6 Packing List	9
2	.System Installation	10
	2.1 CPU Board Outline.....	10
	2.2 Connector Summary.....	11
	2.3 Connector Pin Assignments.....	12
	2.4 External I/O Overview	14
	2.5 External I/O Pin Assignment.....	15
	2.6 System Mapping.....	17
	2.7 Watchdog Timer	20
3	.Driver Installation	21
	3.1 PDX2-057T Development Note	22
	3.2 BIOS Default setting	24
	Warranty.....	25



1. General Information

1.1 Product Description

PDX2-057T is an ultra-compact platform for the present demanding embedded and productive applications. It has new Vortex86DX2 SoC CPU which consumes only minimum power requirement when running at 933MHz, and DDR2 memory provides faster data transfer rate. By using 5.7" TFT LCD, PDX2-057T becomes the perfect choice for a limited budget. In additional, the integrated 10/100M Ethernet port supplies the communication capability which makes PDX2-057T can be more widely used when running with Linux, Windows CE, Windows XP, Windows 7, Windows Embedded environments to become the perfect solution for system integration.

1.2 Product Specification

Table 1-1 Product Specification

CPU Board Specifications	
CPU	DM&P Vortex86DX2 - 933MHz
Cache	L1:16KB I-Cache, 16KB D-Cache L2: 256KB Cache
BIOS	AMI BIOS
Memory	1GB/2GB DDR2 onboard
Watchdog Timer	Software programmable from 30.5u to 512 seconds x 2 sets
LAN	Integrated 10/100M Ethernet
Audio	HD Audio-Realtek ALC262 CODEC
Internal Drives	Compact Flash Type I / II slot Micro SD slot (Optional) 1GB or 2GB Flash Memory onboard (Optional)
I/O	RS-232/422/485 x 1 USB ports (Ver2.0) x 2 RJ-45 Port x 1
Mechanical & Environment	
Power Requirement	Single Voltage +5VDC (PDX2-057T-5A) Multi Voltage +8~+35VDC (PDX2-057T-8A)
Power Consumption	20W (Max.)
Operating Temperature	0 ~ +50°C (32 ~ +122°F) / -20~+60°C (-4 ~ +140°F) Optional & CPU down to 800MHz (-I)
Storage Temp.	-30 ~ +70°C (14 ~ +158°F)

Operating Humidity	0% ~ 90% relative humidity, non-condensing
Dimensions	152 x 112 x 33mm (5.98 x 4.41 x 1.3 inches)
Weight	500g
Certification	CE / FCC / VCCI / Vibration / Shock
LCD Specifications	
Display Type	5.7" TFT LCD
Backlight Unit	LED
Display Resolution	640(W) x 480(H)
Brightness (cd/m ²)	500 nits
Contrast Ratio	300 : 1
Display Color	262, 144
Dot Pitch (mm)	0.06 (W) x 0.18 (H)
Viewing Angle	Vertical 100°, Horizontal 140°
Backlight Lifetime	50,000 hrs
Touchscreen	
Type	Analog Resistive
Resolution	Continuous
Transmittance	80%
Controller	PS / 2 interface
Software Driver	Linux, Win CE, Win XP, Win 7, Windows Embedded Standard
Durability	1 million

1.3 Inspection standard for TFT-LCD Panel

Table 1-2 Inspection Standard

DEFECT TYPE		LIMIT		Note				
VISUAL DEFECT	SPOT	$\phi < 0.15\text{mm}$	Ignore	Note1				
		$0.15\text{mm} \leq \phi \leq 0.5\text{mm}$	$N \leq 4$					
		$0.5\text{mm} < \phi$	$N=0$					
	INTERNAL FIBER	$0.03\text{mm} < W \leq 0.1\text{mm}, L \leq 5\text{mm}$	$N \leq 3$	Note1				
		$1.0\text{mm} < W, 1.5\text{mm} < L$	$N=0$					
	POLARIZER BUBBLE	$\phi < 0.15\text{mm}$	Ignore	Note1				
		$0.15\text{mm} \leq \phi \leq 0.5\text{mm}$	$N \leq 2$					
		$0.5\text{mm} < \phi$	$N=0$					
	Mura	It' OK if mura is slight visible through 6%ND filter						
	ELECTRICAL DEFECT	BRIGHT DOT	A Grade			B Grade		
C Area			O Area	Total	C Area	O Area	Total	
$N \leq 0$			$N \leq 2$	$N \leq 2$	$N \leq 2$	$N \leq 3$	$N \leq 5$	Note2
DARK DOT		$N \leq 2$	$N \leq 3$	$N \leq 3$	$N \leq 3$	$N \leq 5$	$N \leq 8$	
TOTAL DOT			$N \leq 4$		$N \leq 5$	$N \leq 6$	$N \leq 8$	Note2
TWO ADJACENT DOT		$N \leq 0$	$N \leq 1$ pair	$N \leq 1$ pair	$N \leq 1$ pair	$N \leq 1$ pair	$N \leq 1$ pair	Note4
THREE OR MORE ADJACENT DOT		NOT ALLOWED						
LINE DEFECT	NOT ALLOWED							

(1) One pixel consists of 3 sub-pixels, including R, G, and B dot.

(Sub-pixel = Dot)

(2) LITTLE BRIGHT DOT ACCEPTABLE UNDER 6 % ND-Filter

(3) If require G0 grand (Total dot $N \leq 0$), please contact region sales.

[Note 1] W : Width[mm], L : Length[mm], N : Number, ϕ : Average Diameter.

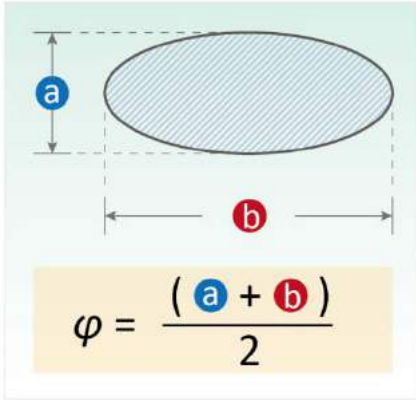

1. White / Black Spot
2. Polarizer Bubble

Fig 1-1

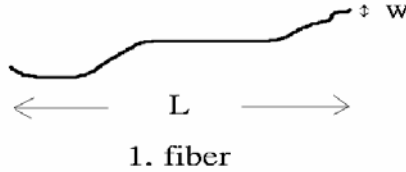

Fig 1-2

[Note 2] Bright dot is defined through 6% transmission ND Filter as following.

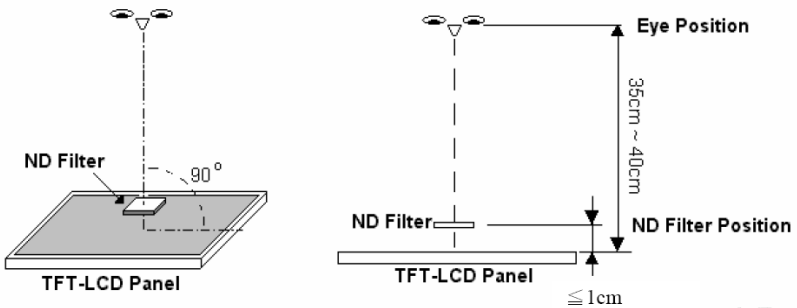
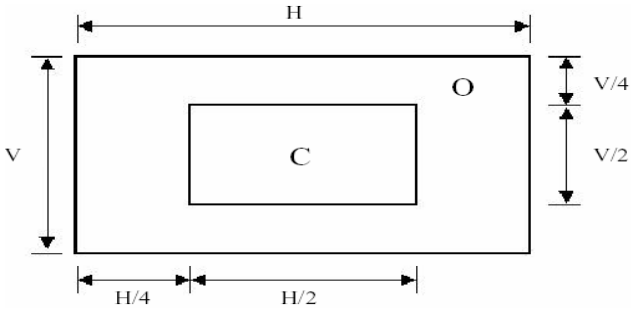

Fig 1-3

[Note 3]



C Area: Center of display area

O Area: Outer of display area

[Note 4]

Judge defect dot and adjacent dot as following. Allow below (as A, B, C and D status) adjacent defect dots, including bright and dart adjacent dot. And they will be counted 2 defect dots in total quantity.

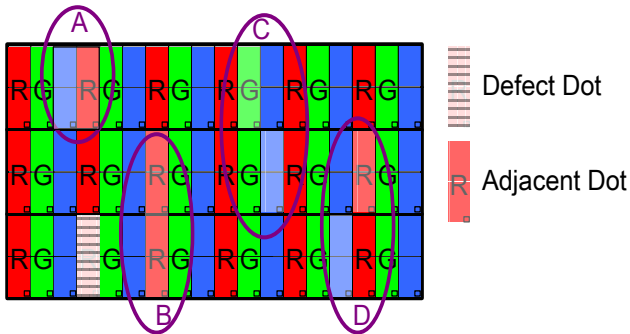

- (1) The defects that are not defined above and considered to be problem shall be reviewed and discussed by both parties.

Defects on the Black Matrix, out of Display area, are not considered as a defect or counted.

1.4 Product Dimension

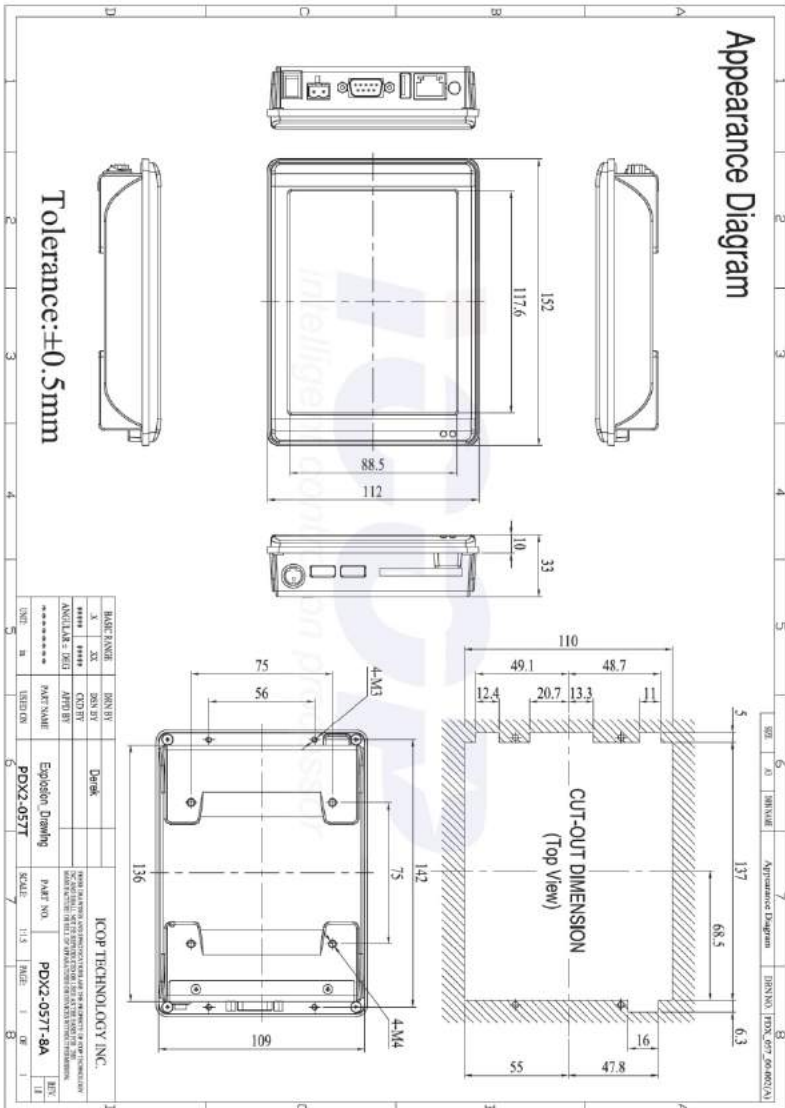

1.5 Ordering Information

Table 1-3 Ordering Information

PART NUMBER	DESCRIPTION
PDX2-057T-5A	5.7" Panel PC w/1GB DDR2 / 2USB / Line-Out / LAN / COM / CF / MicroSD / Power Adapter
PDX2-057T-8A	5.7" Panel PC w/1GB DDR2 / 2USB / Line-Out / LAN / COM / CF / MicroSD / 8-35 DC Support
PDX2-057T-5A-2G	5.7" Panel PC w/2GB DDR2 / 2USB / Line-Out / LAN / COM / CF / MicroSD / Power Adapter
PDX2-057T-8A-2G	5.7" Panel PC w/2GB DDR2 / 2USB / Line-Out / LAN / COM / CF / MicroSD / 8-35 DC Support
PDX2-057T-5A-I	5.7" Panel PC w/1GB DDR2 / Wide Temp. / 2USB / Line-Out / LAN / COM / CF / MicroSD / Power Adapter
PDX2-057T-8A-I	5.7" Panel PC w/1GB DDR2 / Wide Temp. / 2USB / Line-Out / LAN / COM / CF / MicroSD / 8-35 DC Support
PDX2-057T-5A-2G-I	5.7" Panel PC w/2GB DDR2 / Wide Temp. / 2USB / Line-Out / LAN / COM / CF / MicroSD / Power Adapter
PDX2-057T-8A-2G-I	5.7" Panel PC w/2GB DDR2 / Wide Temp. / 2USB / Line-Out / LAN / COM / CF / MicroSD / 8-35 DC Support

1.6 Packing List

Table 1-4 Packing List

PART NUMBER		PACKAGE
PDX2-057T-5A	PDX2-057T-5A	Power-20W-3PIN
PDX2-057T-8A	PDX2-057T-8A	
PDX2-057T-5A-2G	PDX2-057T-5A-2G	Power-20W-3PIN
PDX2-057T-8A-2G	PDX2-057T-8A-2G	
PDX2-057T-5A-I	PDX2-057T-5A-I	Power-20W-3PIN
PDX2-057T-8A-I	PDX2-057T-8A-I	
PDX2-057T-5A-2G-I	PDX2-057T-5A-2G-I	Power-20W-3PIN
PDX2-057T-8A-2G-I	PDX2-057T-8A-2G-I	
WLAN KIT (Optional)	USB-WLAN-IPEX-KIT	
	WIRELESS-ANTENNA-157	
	WIRELESS-CABLE-150MM	

2. System Installation

2.1 CPU Board Outline

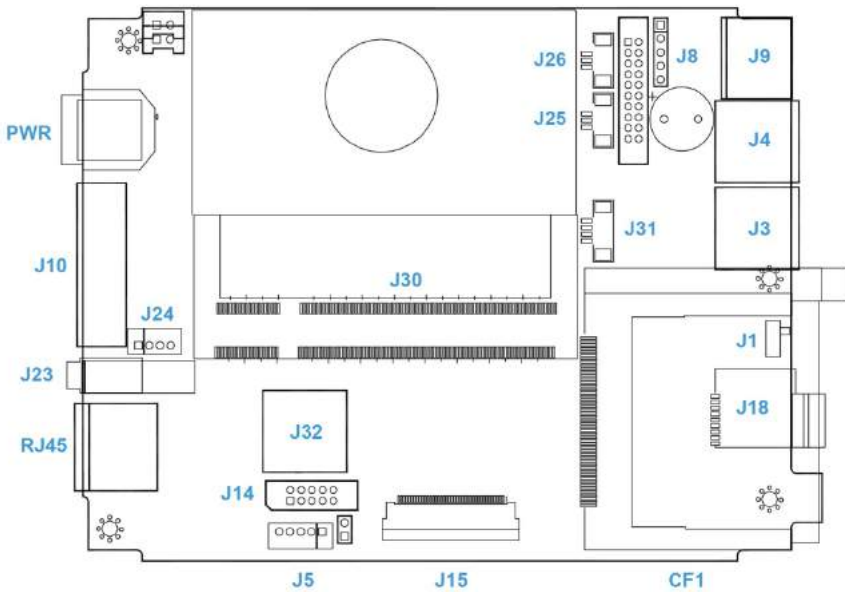

Fig 2-1 PDX2 CPU Board

2.2 Connector Summary

Table 2-1 Summary Table

Nbr	Description	Type of Connections	Pin nbrs.
J1	CF Master/Slave Switch	Slide Switch	ON/OFF
J3	USB	External USB Connector	6-pin
J4	USB	External USB Connector	6-pin
J5	USB (Optional)	2.0mm 5-pin wafer	5-pin
J8	PS/2 Keyboard	2.54mm 5-pin box header	5-pin
J9	PS/2Keyboard	External Mini DIN Socket	6-pin
J10	COM1(RS232/422/485)	External D-Sub Male Connector	9-pin
J14	VGA	2.0mm 10-pin box header	10-pin
J18	Micro SD Card Socket (Optional)	Micro SD socket	
J23	Audio Line-Out	1.25mm Phone Jack	
J24	Audio Mic-In	2.0mm 4-pin wafer	4-pin
J25	COM3 (TX, RX)	1.25mm 3-pin wafer	3-pin
J26	COM4 (TX, RX)	1.25mm 3-pin wafer	3-pin
J30	SOM CPU Board Socket	SOM CPU Board Socket	200-pin
J31	4-Wires Touch connector	1.25mm 4-pin wafer	4-pin
J32	USB (WLAN Optional)	Internal USB Connector	6-pin
RJ45	Ethernet	External RJ45 Connector	8-pin
PWR	Power Connector (5A)	External Mini DIN Socket	3-pin
PWR	Power Connector (8A)	External Power Plug	2-pin
CF1	CF Card Socket	CF Type I/II Socket	

2.3 Connector Pin Assignments

J1: CF Master/Slave Switch

Pin #	Signal Name
On	Master
OFF	Slave

J3: USB

Pin #	Signal Name	Pin #	Signal Name
1	VCC	2	USB D2-
3	USB D2+	4	GND
5	GND	6	GND

J4: USB

Pin #	Signal Name	Pin #	Signal Name
1	VCC	2	USB D3-
3	USB D3+	4	GND
5	GND	6	GND

J5: USB (Optional)

Pin #	Signal Name
1	VCC
2	USB D1-
3	USB D1+
4	GND
5	GND

J8: PS/2 Keyboard

Pin #	Signal Name	Pin #	Signal Name
1	KBCLK	2	KBDAT
3	NC	4	GND
5	VCC		

J9: PS/2 Keyboard

Pin #	Signal Name	Pin #	Signal Name
1	KBCLK	2	MSCLK
3	GND	4	KBDATA
5	MSDATA	6	VCC
7	GND	8	GND
9	GND		

J10: COM1 RS232/422/485 (Change setting by BIOS)

Pin #	Signal Name	Pin #	Signal Name
1	DCD1/ 422TX- / RS485-	2	RXD1 / 422TX+ / RS485+
3	TXD1 / 422RX+	4	DTR1 / 422RX-
5	GND	6	DSR1
7	RTS1	8	CTS1
9	RI1		

J14: VGA

Pin #	Signal Name	Pin #	Signal Name
1	R OUT	2	GND
3	G OUT	4	GND
5	B OUT	6	GND
7	HSYNC	8	GND
9	VSYNCD	10	GND

J24: MIC-IN

Pin #	Signal Name
1	MICVREF
2	GND
3	GND
4	MIC-IN

J25: COM3 (TX, RX)

Pin #	Signal Name
1	GND
2	TXD3
3	RXD3

J26: COM4 (TX, RX)

Pin #	Signal Name
1	GND
2	TXD4
3	RXD4

J31: 4-Wires Touch connector

Pin #	Signal Name
1	Y-
2	X-
3	Y+
4	X+

J32: USB (WLAN Optional)

Pin #	Signal Name	Pin #	Signal Name
1	VCC	2	USB2-
3	USB2+	4	GND
5	GND	6	GND

PWR: Power Connector (5A)

Pin #	Signal Name
1	+5V
2	GND
3	NC
4	GND

PWR: Power Connector (8A)

Pin #	Signal Name
1	+ 8 ~ 35V
2	GND

2.4 External I/O Overview

{ PDX2-057T-8A / PDX2-057T-8A-2G }



Fig 2-2 PDX2-057T-8A I/O overview

{ PDX2-057T-5A / PDX2-057T-5A-2G }



Fig 2-3 PDX2-057T-5A I/O overview

{Note}

1. WLAN is optional
2. COM1 RS232/422/485 is selected by BIOS setting
3. Micro SD Socket is optional (Either one of CF or Micro SD)

2.5 External I/O Pin Assignment

Power Switch

	Pin #	Status
	I	ON
	O	OFF

Power Connector (5A)

	Pin #	Signal Name
	1	+5V
	2	GND
	3	NC

Power Connector (8A)

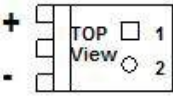
	Pin #	Signal Name
	1	+8 ~ 35V
	2	GND

Audio Line-Out

	Pin #	Signal Name
	1	GND
	2	LOUTL
	3	Open Touch
	4	Open Touch
	5	VREFOUT

USB Port

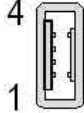
	Pin #	Signal Name
	1	VCC
	2	USB0-
	3	USB0+
	4	GND
	5	GGND
6	GGND	

PS/2 Keyboard

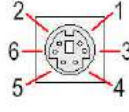
	Pin #	Signal Name
	1	KBCLK
	2	PMCLK
	3	GND
	4	KBDAT
	5	PMDAT
6	SB5V	

J10: COM1 RS232/422/485 (Change setting by BIOS)

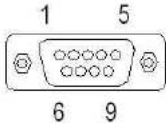
	Pin #	Signal Name	Pin #	Signal Name
	1	DCD1/422TX-/RS485-	2	RXD1/422TX+/RS485+
	3	TXD1 / 422RX+	4	DTR1 / 422RX-
	5	GND	6	DSR1
	7	RTS1	8	CTS1
	9	RI1		

RJ45

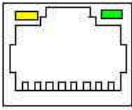
	Pin #	Signal Name	Pin #	Signal Name
	1	FTXD+	2	FTXD-
	3	FRXIN+	4	NC
	5	NC	6	FRXIN-
	7	NC	8	NC

2.6 System Mapping

Table 2-2 Technical Data Sheet

System Mapping

Memory Mapping		
Address	Description	Usage
00000000-0009FFFF	System RAM	*
000A0000-000AFFFF	EGA/VGA Video Memory	*
000B0000-000B7FFF	MDA RAM, Hercules Graphics Display RAM	*
000B8000-000BFFFF	CGA Display RAM	*
000C0000-000C7FFF	EGA/VGA BIOS ROM	*
000C8000-000CFFFF	Boot ROM Enable	
000CC000-000CFFFF	Console Redirection Enable	
000D0000-000DFFFF	Expansion ROM Space	
000E0000-000EFFFF	USB Legacy SCSI ROM Space	
000F0000-000FFFFFFF	Motherboard BIOS	*
FEBDE000-FEBDEFFF	Standard OpenHCD USB Host Controller	*
FEBDFC00-FEBDFCFF	On board Ethernet Adapter	*

I/O Mapping		
I/O Address	Owner	Usage
0000h - 000Fh	DMA 8237-1	*
0020h - 0021h	PIC 8259-1	*
0022h - 0023h	Indirect Access Registers (6117D configuration port)	*
0040h - 0043h	Timer counter 8254	*
0048h - 004Bh	PWM counter 8254	*
0060h	Keyboard / Mouse Data Port	*

0061h	Port B + NMI Control Port	*
0062h - 0063h	8051 download 4K Address Counter	*
0064h	Keyboard / Mouse Status / Command Port	*
0065h	WatchDog0 Reload Counter	*
0070h - 0071h	CMOS RAM Port	*
0072h - 0075h	MTBF Control Register	*
0078h - 007Ch	GPIO Port 0,1,2,3,4 Default Setup	*
0080h - 008Fh	DMA Page Register	*
0092h	System Control Register	*
0098h - 009Ch	GPIO Direction Control	*
00A0h - 00A1h	PIC 8259-2	*
00A8h - 00ADh	WatchDog1 Control Register	*
00AEh	WatchDog1 Reload Counter	*
00C0h - 00DFh	DMA 8237-2	*
00E0h - 00EFh	DOS 4G Page Access	*
0170h - 0177h	IDE1 (IRQ 15)	*
02E8h - 02EFh	COM4 (IRQ 11)	
02F8h - 02FFh	COM2 (IRQ 3)	
03E8h - 03EFh	COM3 (IRQ 10)	
03F6h	IDE0 ATAPI Device Control Write only Register	*
03F8h - 03FFh	COM1 (IRQ 4)	*
0480h - 048Fh	DMA High Page Register	*
0490h - 0499h	Instruction Counter Register	*
04D0h - 04D1h	8259 Edge,/ Level Control Register	*
0CF8h - 0CFFh	PCI configuration port	*
D800h - D8FFh	On Board LAN	*
FC00h - FC05h	SPI Flash BIOS Control Register (internal SPI Flash Base address)	*

IRQ Mapping

IRQ#	Description	Usage
IRQ0	System Timer	*
IRQ1	Keyboard Controller	*
IRQ2	Cascade for IRQ8 - 15	
IRQ3	USB	*
IRQ4	Serial Port 1	*
IRQ5	USB	*
IRQ6	Unassigned	
IRQ7	USB	*
IRQ8	Real Time Clock	*
IRQ9	Audio	*
IRQ10	USB	*
IRQ11	Ethernet 10/100M LAN	*
IRQ12	Mouse	*
IRQ13	Math Coprocessor	*
IRQ14	Hard Disk Controller#1	*
IRQ15	Hard Disk Controller#2	*

DMA Mapping

DMA#	Description	Usage
DMA0		
DMA1		
DMA2	Floppy Disk Controller (Reserved)	
DMA3		
DMA5		
DMA6		
DMA7		



2.7 Watchdog Timer

There are two watchdog timers in PDX2-057T, we also provide DOS, Linux and WinCE example for your reference. For more technical support, please visit: <http://tech.icop.com.tw> or download the PDF file: dmp.com.tw/tech

3.Driver Installation

VGA

The Vortex86DX2 processor is integrated RDC Display chip which is an ultra low powered graphics chipset with total power consumption at around 1-1.5 W.

LAN

The Vortex86DX2 processor is integrated 10/100Mbps Ethernet controller that supports both 10/100BASE-T and allows direct connection to your 10/100Mbps Ethernet based Local Area Network for full interaction with local servers, wide area networks such as the Internet.

I/O and IRQ settings can be done by software with the supplied utility software, or it can be set for Plug and Play compatibility. The controller supports: Half / Full-Duplex Ethernet function to double channel bandwidth, auto media detection.

AUDIO

The ALC262 series are 4-Channel High Definition Audio Codecs with UAA (Universal Audio Architecture) featuring two 24-bit stereo DACs and three 20-bit stereo ADCs, they are designed for high performance multimedia desktop and laptop systems. The ALC262 series incorporates proprietary converter technology to achieve over 100dB Signal-to-Noise ratio playback quality; easily meeting PC2001 requirements and also bringing PC sound quality closer to consumer electronic devices.

Operating system support

The PDX2-057T provides the VGA and LAN drivers for Linux, Windows CE, Windows XP Professional, Windows 7, and Windows Embedded standard (WES2009 / WES7).

Please get the drivers from ICOP official website: tech.icop.com.tw

PDX2-057T also supports most of the popular Linux distributions, for more detail information, please visit DMP official website: dmp.com.tw/tech/

3.1 PDX2-057T Development Note

<Primary IDE: Master or Slave>

1. Primary IDE Device can be either one of CF or Micro SD and the standard version is for CF slot only.
2. CF Slot: Primary IDE: Master or Slave (User can use slide switch (in side of CF slot) to adjust Master or Slave
3. Micro SD (Optional): Primary Master only

<Window CE6.0 and Compact 7 development guide>

Windows Embedded CE 6.0 and Compact 7 BSPs, trial CE image and development notes, please visit technical website to get more information: tech.icop.com.tw



<Linux installation note>

Please forced the IDE setting in BIOS to PIO mode before install Linux on PDX2-057T as follows:

Go to the advanced BIOS setting and make the “Onboard IDE Operate Mode” is “Legacy Mode”

< Windows XP and Windows 7 installation note >

Please visit technical website to get more information: tech.icop.com.tw

3.2 BIOS Default setting

If the system cannot be booted after BIOS changes are made, Please follow below procedures in order to restore the CMOS as default setting.



Press < **End** > Key, when the power on



Press < **Del** > to enter the AMI BIOS setup



Press < **F9** > to Load Optimized defaults



Press < **F10** > to Save configuration changes and exit setup



Warranty

This product is warranted to be in good working order for a period of one year from the date of purchase. Should this product fail to be in good working order at any time during this period, we will, at our option, replace or repair it at no additional charge except as set forth in the following terms. This warranty does not apply to products damaged by misuse, modifications, accident or disaster. Vendor assumes no liability for any damages, lost profits, lost savings or any other incidental or consequential damage resulting from the use, misuse of, originality to use this product. Vendor will not be liable for any claim made by any other related party. Return authorization must be obtained from the vendor before returned merchandise will be accepted. Authorization can be obtained by calling or faxing the vendor and requesting a Return Merchandise Authorization (RMA) number. Returned goods should always be accompanied by a clear problem description.

All Trademarks appearing in this manuscript are registered trademark of their respective owners.

All Specifications are subject to change without notice.

©ICOP Technology Inc. 2017